

Seating configurations and dimensions.

Please note that these renderings are designed to provide you with estimated space requirements.

Continental Seating products are hand crafted and variations from standard dimensions and appearances can occur.

NOTE: Power mechanisms will raise seat height approximately 2 inches. Power mechanisms DO NOT recline as far back as the standard and wall saver mechanisms.

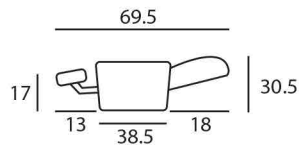

STANDARD Recliner Mechanism

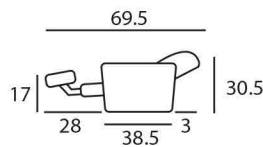

WALLSAVER Recliner Mechanism

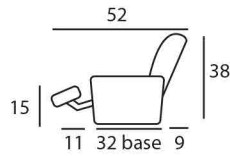

Partially Reclined

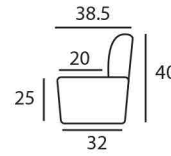

Side View

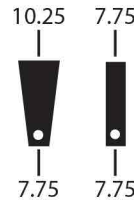

H: 40
D: 38.5 Seat: 24
W: 65.5

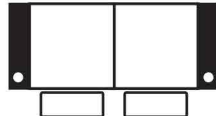

2 Arm Loveseat



2 Arm Recliner

H: 40
D: 38.5 Seat: 24
W: 41

H: 40
D: 38.5 Seat: 24
W: 73.5



2 Seat Straight

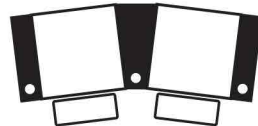

2 Seat Curve

H: 40
D: 38.5 Seat: 24
W: 76

H: 40
D: 38.5 Seat: 24
W: 106

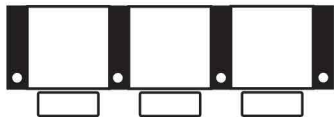

3 Seat Straight

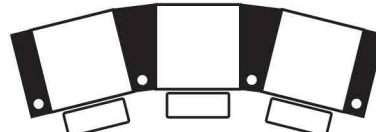

3 Seat Curve

H: 40
D: 38.5 Seat: 24
W: 111

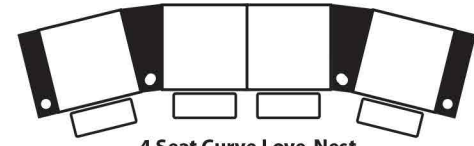

4 Seat Curve Love-Nest

H: 40
D: 38.5 Seat: 24
W: 131



4 Seat Straight Love-Nest

H: 40
D: 38.5 Seat: 24
W: 136

H: 40
D: 38.5 Seat: 24
W: 139



4 Seat Straight

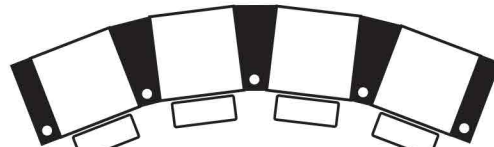

4 Seat Curve

H: 40
D: 38.5 Seat: 24
W: 147

This is a sample representation of the most popular seating configurations & dimensions to help you prepare your order
You can arrange seating in any configuration you desire!

Seating configurations and dimensions.

Please note that these renderings are designed to provide you with estimated space requirements.

Continental Seating products are hand crafted and variations from standard dimensions and appearances can occur.

NOTE: Power mechanisms will raise seat height approximately 2 inches. Power mechanisms DO NOT recline as far back as the standard and wallsaver mechanisms.

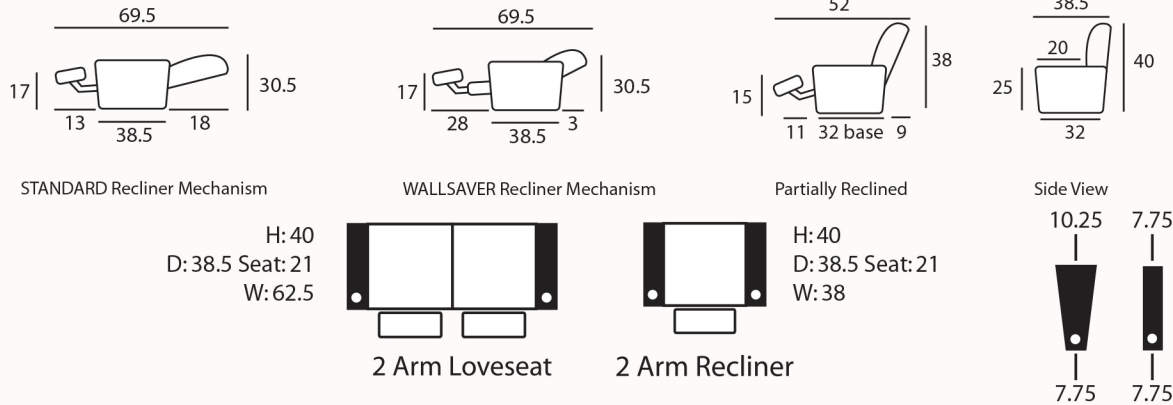

H: 40
D: 38.5 Seat: 21
W: 62.5



2 Arm Loveseat



2 Arm Recliner

H: 40
D: 38.5 Seat: 21
W: 38

H: 40
D: 38.5 Seat: 21
W: 67.5



2 Seat Straight



2 Seat Curve

H: 40
D: 38.5 Seat: 21
W: 70

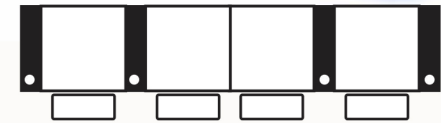

4 Seat Straight Love-Nest

H: 40
D: 38.5 Seat: 21
W: 119

H: 40
D: 38.5 Seat: 21
W: 97



3 Seat Straight

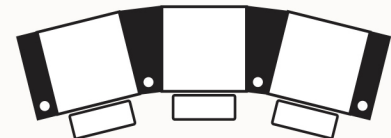

3 Seat Curve

H: 40
D: 38.5 Seat: 21
W: 102

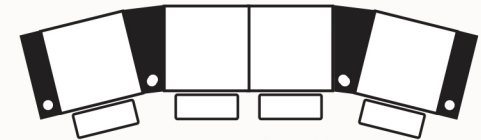

4 Seat Curve Love-Nest

H: 40
D: 38.5 Seat: 21
W: 124

H: 40
D: 38.5 Seat: 21
W: 127

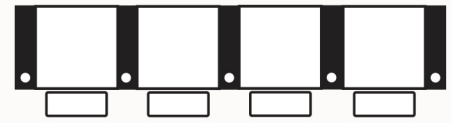

4 Seat Straight

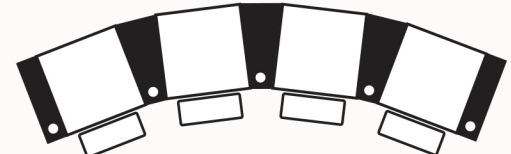

4 Seat Curve

H: 40
D: 38.5 Seat: 21
W: 135

This is a sample representation of the most popular seating configurations & dimensions to help you prepare your order. You can arrange seating in any configuration you desire!